

Fans and Blowers



Advanced Bulk and Conveying, Inc., is a supplier of high quality fans and blowers. These blowers can be used to exhaust dusty air and to convey many types of materials. The direct drive, cast aluminum housing PB model pressure blower is most popular because of its non-corrosive product contact area, simple design, large size range, and low cost.

Model PB Blower Features:

- Cast Aluminum 2-Piece Housing
- 9 Standard Arrangements
- Optional Accessories
- 8 Standard Sizes

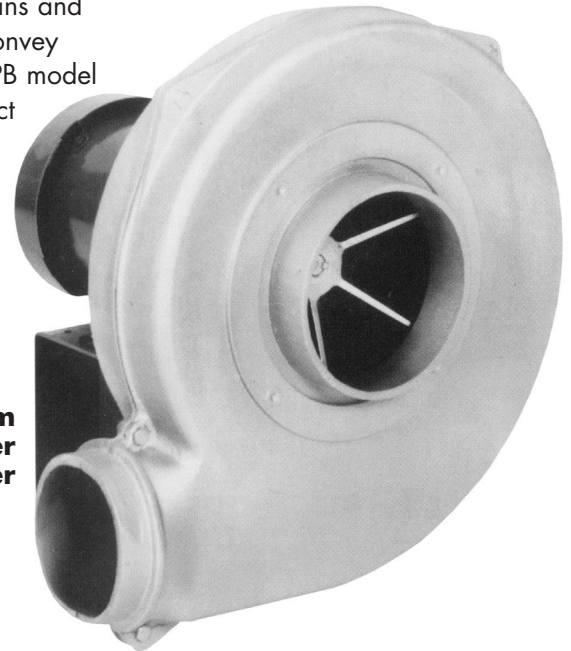

Model PB Cast Aluminum Pressure Blower for Material and Air Transfer

16 Discharge Positions Available.

45° Discharge Positions Not Shown.

Discharges shown are determined by viewing fan from motor or drive side.



Clockwise Top Horizontal Discharge



Clockwise Down-Blast Discharge



Clockwise Bottom Horizontal Discharge



Clockwise Up-Blast Discharge



Counter-Clockwise Top Horizontal Discharge



Counter-Clockwise Down-Blast Discharge

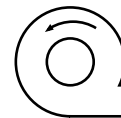

Counter-Clockwise Bottom Horizontal Discharge



Counter-Clockwise Up-Blast Discharge

9 Standard Arrangements



Arrangement 4
(Foot & flange motor)

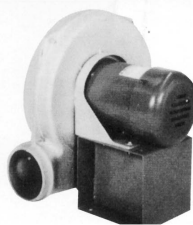

Arrangement 4
(Flange mount-footless motor)

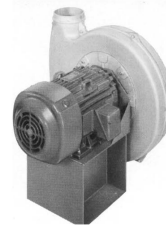

Arrangement 4
(Foot mounted motor)



Arrangement 4HM
(Horizontal mount)

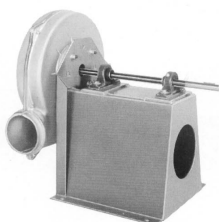

Arrangement 1

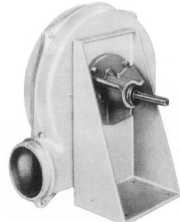

Arrangement 2

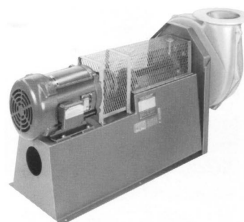

Arrangement 8

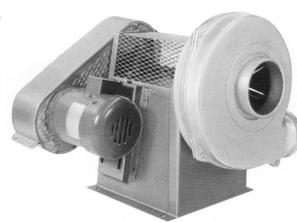

Arrangement 9

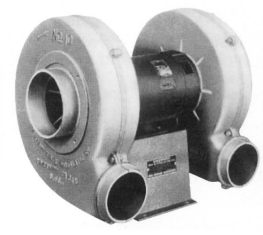

Arrangement 4D
(Double blower unit)

Fans (continued)

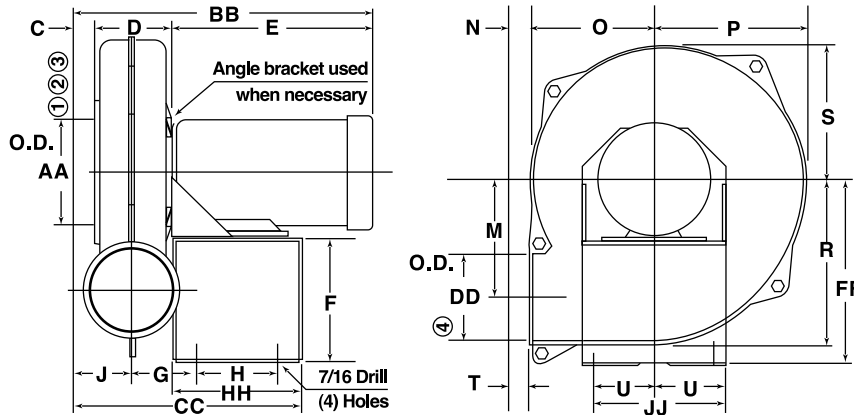

* Varies With Motor

- ① PB-14A also available with 6" and 8" inlets.
- ② PB-15A and PB-18 also available with 6" and 10" inlets.
- ③ PB-18WA also available with 8" inlet.
- ④ All models, discharge flange not available for down blast position.

MODEL	C	D	J	M	N	O	P	R	S	T	AA ①②③	DD ④
PB-8	1	3 3/4	2 7/8	4 1/8	1 1/8	4 5/8	5 9/16	6 1/2	4 7/8	1 1/8	4	4
PB-9	1 1/16	4 1/8	3 1/8	5 5/8	1 3/16	6 1/16	7 1/2	7 7/8	6 5/8	1	5	4
PB-10A	1 1/4	4 1/4	3 3/8	6 9/16	1	6 7/8	9 7/16	8 15/16	7 13/16	1	6	5
PB-12A	1 1/4	5	3 3/4	7 9/16	7/8	8	9 5/8	11	9 7/16	1	7	6
PB-14A	1 1/4	6	4 1/4	8 1/16	1 1/8	8 11/16	10 1/4	11 5/16	10 1/4	1	7 ①	6
PB-15A	1 1/4	7 1/4	4 7/8	7 7/8	1	9 13/16	11 3/8	12 13/16	10 13/16	1	8 ②	8
PB-18	1 1/4	6 1/4	4 3/8	10 1/2	15/16	10 1/2	12 11/16	13 3/4	11 3/8	1	8 ②	6
PB-18WA	1 1/4	8 1/16	5 5/16	9 7/8	7/8	11	12 7/8	14 1/8	11 13/16	1	10 ③	8

MODEL	Motor Frame	E*	F	G	H	U	BB*	CC	FF	HH	JJ
PB-8	56	12 1/2	5	3 3/16	5	2 3/4	17 1/4	12 1/8	8 9/16	7 1/8	7
PB-9	56	12 1/2	6 7/8	3 3/8	5 3/4	2 3/4	17 11/16	13 5/16	10 7/16	7 7/8	7
	143T - 145T	12	8 1/4	4 3/16	5	3 3/4	17 3/16	13 13/16	11 7/8	8	9
PB-10A	56	12 1/2	6 7/8	3 7/16	5 3/4	2 3/4	18	13 11/16	10 7/16	7 7/8	7
	143T - 145T	12	8 1/4	4 1/4	5	3 3/4	17 1/2	14 3/16	11 7/8	8	9
PB-12A	56	12 1/2	8 1/4	4 1/4	5	3 3/4	18 3/4	14 1/2		8	9
	143T - 145T	12	8 1/4	4 5/8	5	3 3/4	18 1/4	14 7/8	11 7/8	8	9
	182T - 184T	15 1/2	6 7/16	5	8 3/4	4 15/16	21 3/4	19		11 3/4	12
PB-14A	56	12 1/2					19 3/4				
	143T - 145T	12	9 15/16	5 1/2	8 3/4	4 15/16	19 1/4	20	15 3/16	11 3/4	12
	182T - 184T	15 1/2					22 3/4				
PB-15A	182T - 184T	15 1/2					24				
	213T - 215T	16	9 15/16	6 1/8	8 3/4	4 15/16	24 1/2	21 1/4	15 3/16	11 3/4	12
	254T - 256T	19	8 15/16		13		27 1/2	25 1/2		16	16 1/2
PB-18	182T - 184T	15 1/2	9 15/16		8 3/4	4 15/16	23	20 1/4	15 3/16	11 3/4	12
	213T - 215T	16		5 5/8			23 1/2				
	254T - 256T	19	8 15/16		13		26 1/2	24 1/2		16	16 1/2
PB-18WA	182T - 184T	15 1/2					24 13/16	24 1/16		13 3/4	
	213T - 215T	16	12 3/4	6 1/2	10 3/4	6 1/4	25 5/16		18		16 1/2
	254T - 256T	19	11 3/4				28 5/16				
	284T - 286T	22	11		15 3/4		31 5/16	29 1/16		18 3/4	

Other Fan Products Include:

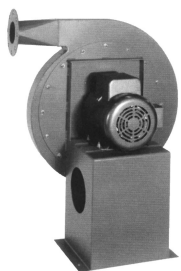

HIGH PRESSURE BLOWERS



MANCOOLERS

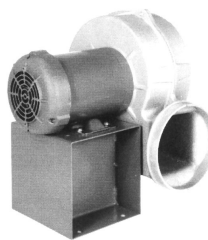

CAST ALUMINUM VOLUME BLOWERS

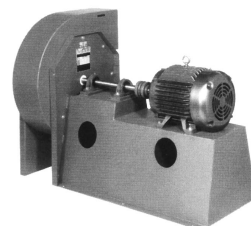

INDUSTRIAL EXHAUSTERS

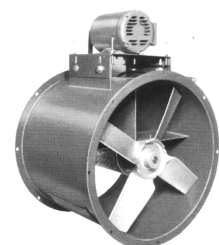

TUBE AXIAL FANS